

# OWLOTECH

OW-REC-MAG-GR

## **AI Recorder Magnus** **Grabadora IA Magnus**

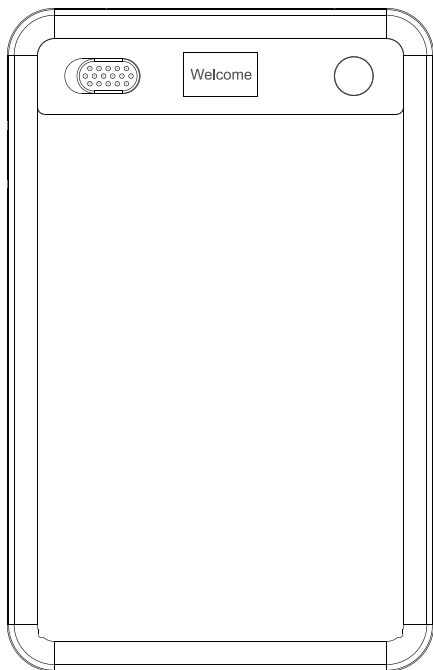



Download the 「AI DVR Link」 App to activate Recorder upon first use.



Importado por:  
CIF: B88237342 para OWLOTECH  
C/ Isabel Colbrand 10. Of. 78 28050 Madrid  
OW-REC-MAG-GR  
Lote 4199  
pl.gpsr@pccomponentes.com  
MADE IN P.R.C

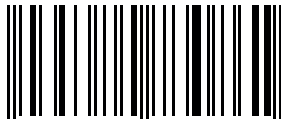

8 435674 730861 1

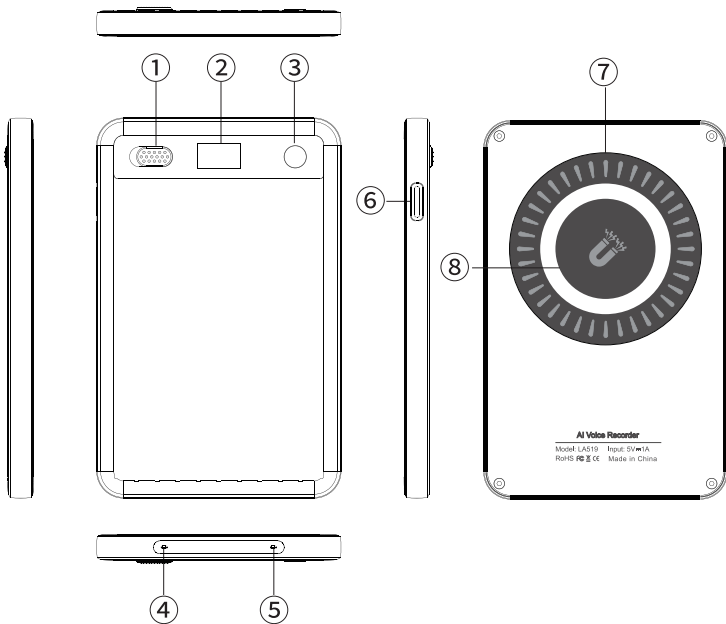

- ① Recording Mode Switch
- ② Screen
- ③ Power/Record Switch
- ④ Microphone
- ⑤ Microphone
- ⑥ Type-C Port
- ⑦ Magnet
- ⑧ Wireless Charging

# Quick Guide



AI DVR Link



- Search for "AI DVR Link" in the App Store or Google Play to download the app.
- Create your App account.

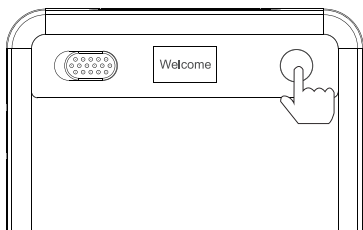

- Long press the Record button for 3 seconds.
- A "Welcome" message will appear on the screen.

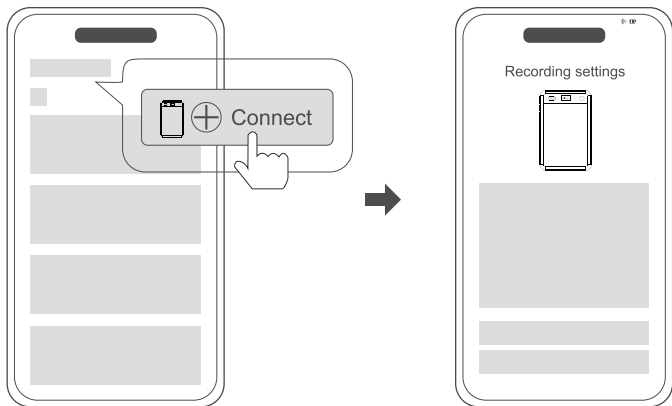

- Open the "AI DVR Link" app and follow the on-screen instructions to bind the device.
- Upon successful binding, the device will display the Bluetooth icon shown above.

# Start Recording

## **NOTE Recording Mode**

- Toggle right to enter NOTE recording mode.
- In this mode, hold Recorder in your hand or place it on a desk to start recording.

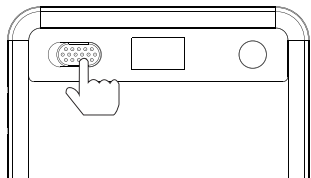

## **CALL Recording Mode**

- Toggle left to enter CALL recording mode.
- In this mode, Recorder can capture the vibration of the phone, providing accurate records.

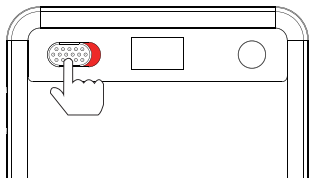

## **Notice**

For phone call recording, you must ensure that the voice recorder is in Call Recording mode and is securely attached to the back of the phone with the supplied MagSafe case.

## Start Recording

Short press the record button and you can feel 1 vibration, indicating that recording has started.

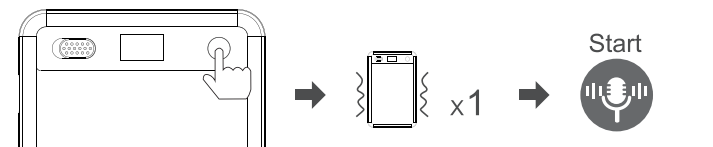

## End Recording

Short press the record button and you can feel 2 vibrations, indicating that the recording has ended.

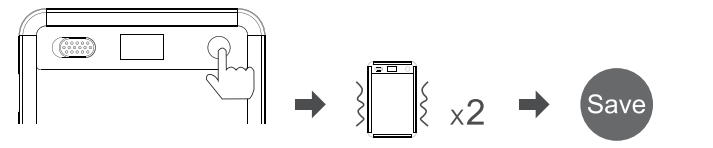

## Start Recording via App

Open the app and tap the Record button to start recording. Ensure AI DVR Link maintains app connection during recording.

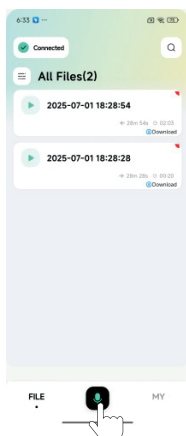

### Notice

#### Auto-Reconnection Feature

When powering off without manual unbinding/disconnection

- The recorder automatically reconnects to AI DVR Link upon restart
- No repeated pairing required for subsequent recordings

## End Recording via App

Tap once during recording to pause, and tap again to **resume**.

Tap the **Save** button to finish and save the recording.



# Recording File Sync

After connecting, existing audio files on the device will appear in the app automatically.

## Before Playback:

1. Synchronize the file with the app
2. Tap the Play button to listen.

1. Please sync the audio file to the app first

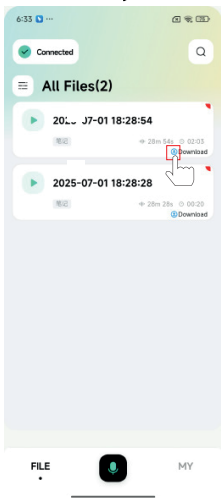

2. Synchronization completed. Click the play button to play the current file.

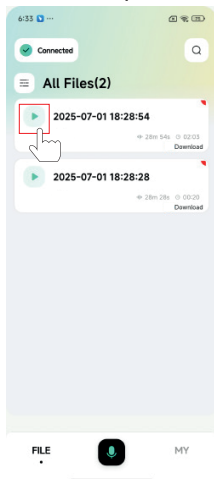

## Recording File Sync via Computer

1. Connect the recorder to your computer using the supplied USB cable.

- The recorder powers on automatically
- Connection icon appears on screen

2. For initial connection:

- Computer prompts for driver installation
- Wait until "My Computer" (Windows) recognizes a new drive

3. When connection is confirmed:

- Transfer/read/manage files

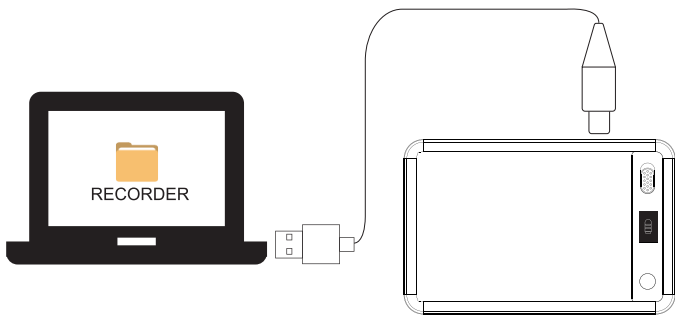

## Warning

Never disconnect during file transfer, as this may cause data loss.

## Support Wireless Charger



(Optional)

# OTG Feature

How to use OTG: Use the included USB cable and OTG adapter to connect the recorder to your cell phone. (The cell phone must have OTG feature)

1. Android phone connected successfully will automatically pop up USB disk prompts, click on it to enter the corresponding folder to manage files.

2. After the iPhone is successfully connected, inside the system folder, select Browse to find the USB disk, then click and find the corresponding folder to manage files.

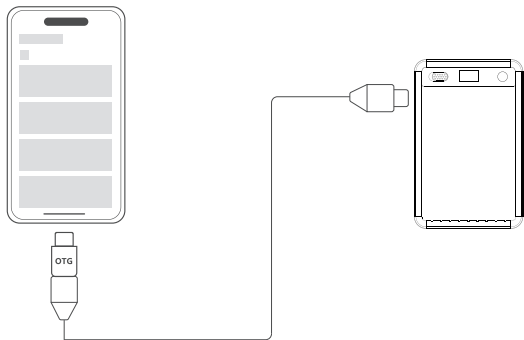

# APP Features

## Transcription Generation

After the audio files are successfully synced to the app, tap on a file to start transcription.

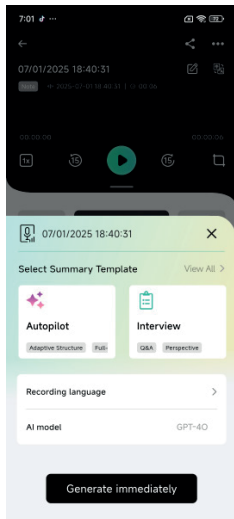
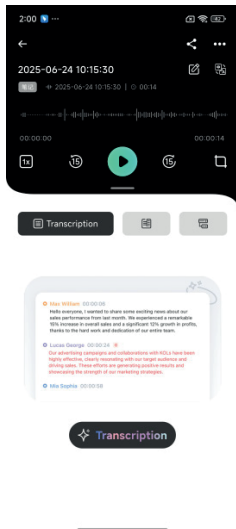

Once the transcription is complete, a **summary** and **mind map** will be generated automatically.

## Manage Files (recordings, transcripts, summaries, mind maps)

After the transcription is finished, you can choose to edit the file name and move it to your customized folders. If you are not satisfied with the transcription or summary, you can re-transcribe or re-summarize the file.

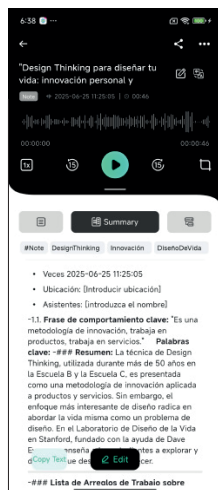

### Notice

Re-transcription will still deduct your transcription minutes. Or you could manually edit the transcripts and summaries by clicking the "Edit" button.

## Export Files(recordings, transcripts,- summaries, mind maps)

If you want to export audio, transcripts, summaries, and mind-maps, there are several formats you can choose:

Export Audio	WAV
Export Transcript	TXT, Markdown, DOCX, PDF
Export Summary	TXT, SRT, DOCX, PDF
Export Mind-map	JPEG, Markdown

# Unbind a Device

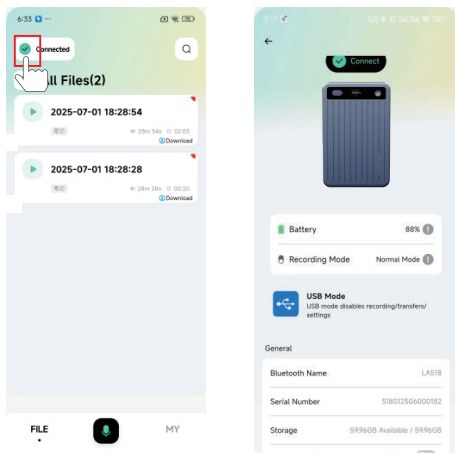

Tap the Connection icon on the main screen to manage device settings:

## 1. Disconnect

End the Bluetooth connection between the device and the app.

## 2. Unbind

Remove the device from the app and clear the binding relationship. In this case, you can connect the device to another cell phone.

# Technical Specifications

USB interface	Type-C USB2.0
Battery Capacity	750 mAh
Memory Capacity	64GB
Rated Input	DC5V 1A
Recording Format	MP3
Working Time	About 90 hours
Weight	54g
Audio Bit Rate	32Kbps
Supported Operating Systems	iOS/Android/ Windows/Linus

# OWLOTECH

OW-REC-MAG-GR

## **AI Recorder Magnus** **Grabadora IA Magnus**

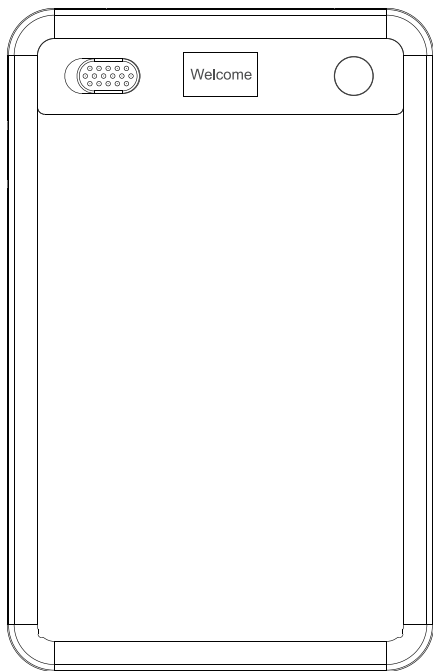



Download the 「AI DVR Link」 App to activate Recorder upon first use.



Importado por:  
CIF: B88237342 para OWLOTECH  
C/ Isabel Colbrand 10. Of. 78 28050 Madrid  
OW-REC-MAG-GR  
Lote 4199  
pl.gpsr@pccomponentes.com  
MADE IN P.R.C

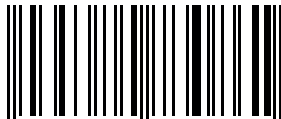

8 435674 730861 1

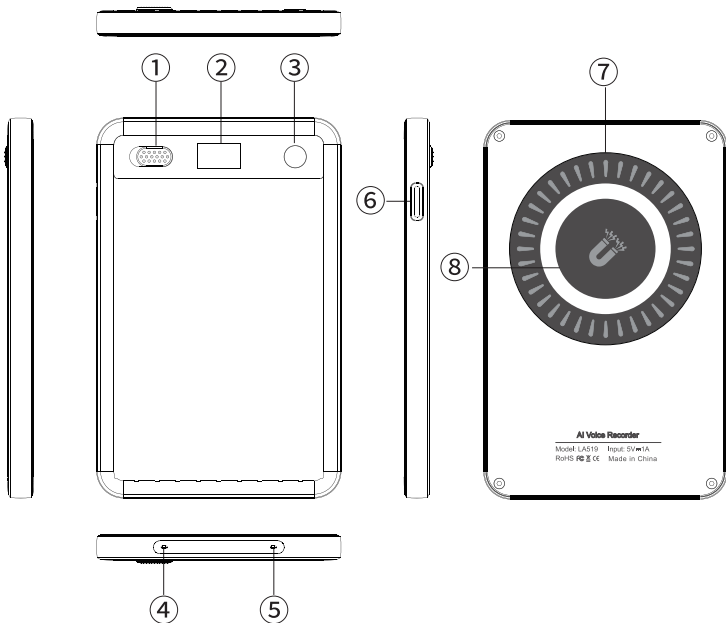

- ① Recording Mode Switch
- ② Screen
- ③ Power/Record Switch
- ④ Microphone
- ⑤ Microphone
- ⑥ Type-C Port
- ⑦ Magnet
- ⑧ Wireless Charging

# Quick Guide



AI DVR Link



- Search for "AI DVR Link" in the App Store or Google Play to download the app.
- Create your App account.

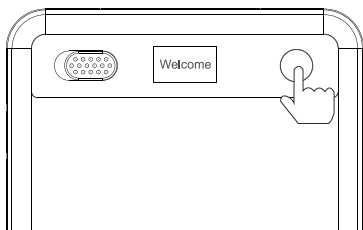

- Long press the Record button for 3 seconds.
- A "Welcome" message will appear on the screen.

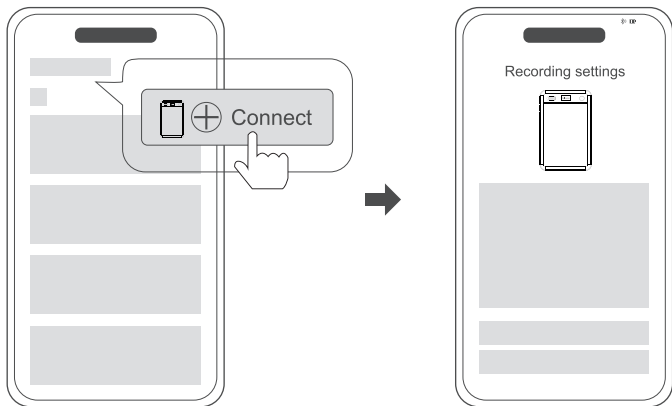

- Open the "AI DVR Link" app and follow the on-screen instructions to bind the device.
- Upon successful binding, the device will display the Bluetooth icon shown above.

# Start Recording

## **NOTE Recording Mode**

- Toggle right to enter NOTE recording mode.
- In this mode, hold Recorder in your hand or place it on a desk to start recording.

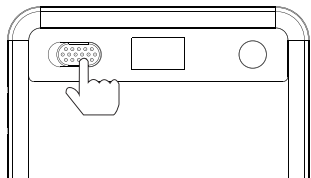

## **CALL Recording Mode**

- Toggle left to enter CALL recording mode.
- In this mode, Recorder can capture the vibration of the phone, providing accurate records.

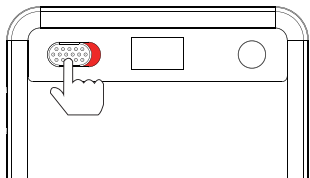

## **Notice**

For phone call recording, you must ensure that the voice recorder is in Call Recording mode and is securely attached to the back of the phone with the supplied MagSafe case.

## Start Recording

Short press the record button and you can feel 1 vibration, indicating that recording has started.

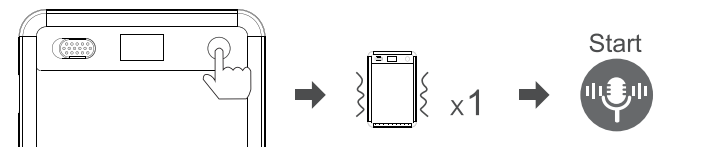

## End Recording

Short press the record button and you can feel 2 vibrations, indicating that the recording has ended.

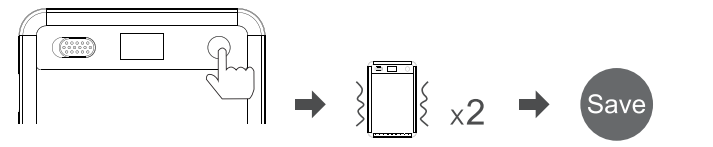

## Start Recording via App

Open the app and tap the Record button to start recording. Ensure AI DVR Link maintains app connection during recording.

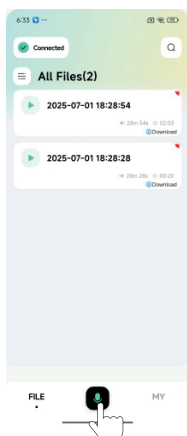

### Notice

#### Auto-Reconnection Feature

When powering off without manual unbinding/disconnection

- The recorder automatically reconnects to AI DVR Link upon restart
- No repeated pairing required for subsequent recordings

## End Recording via App

Tap once during recording to pause, and tap again to **resume**.

Tap the **Save** button to finish and save the recording.



# Recording File Sync

After connecting, existing audio files on the device will appear in the app automatically.

## Before Playback:

1. Synchronize the file with the app
2. Tap the Play button to listen.

1. Please sync the audio file to the app first

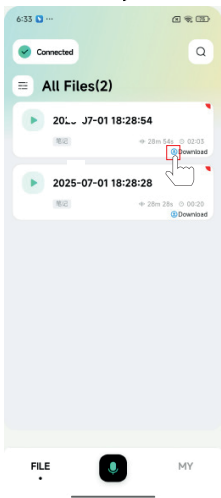

2. Synchronization completed. Click the play button to play the current file.

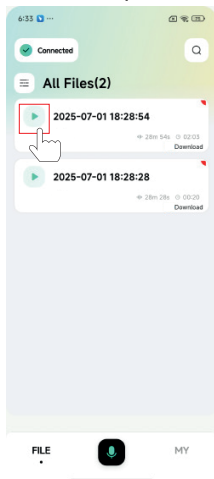

## Recording File Sync via Computer

1. Connect the recorder to your computer using the supplied USB cable.

- The recorder powers on automatically
- Connection icon appears on screen

2. For initial connection:

- Computer prompts for driver installation
- Wait until "My Computer" (Windows) recognizes a new drive

3. When connection is confirmed:

- Transfer/read/manage files

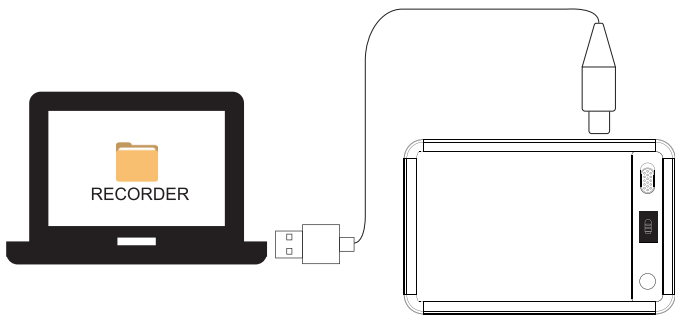

## Warning

Never disconnect during file transfer, as this may cause data loss.

## Support Wireless Charger



(Optional)

# OTG Feature

How to use OTG: Use the included USB cable and OTG adapter to connect the recorder to your cell phone. (The cell phone must have OTG feature)

1. Android phone connected successfully will automatically pop up USB disk prompts, click on it to enter the corresponding folder to manage files.

2. After the iPhone is successfully connected, inside the system folder, select Browse to find the USB disk, then click and find the corresponding folder to manage files.

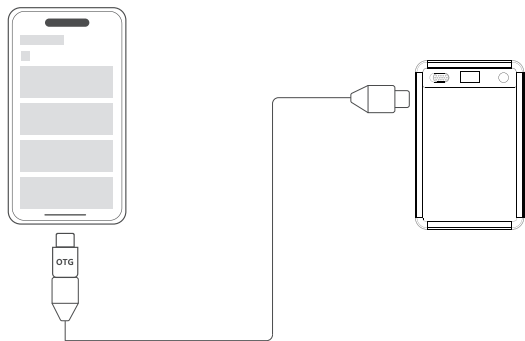

# APP Features

## Transcription Generation

After the audio files are successfully synced to the app, tap on a file to start transcription.

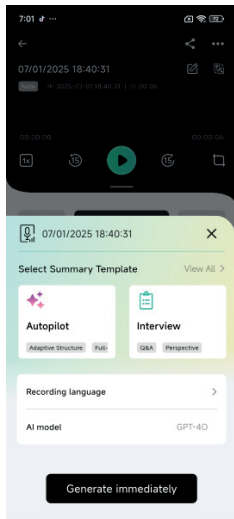
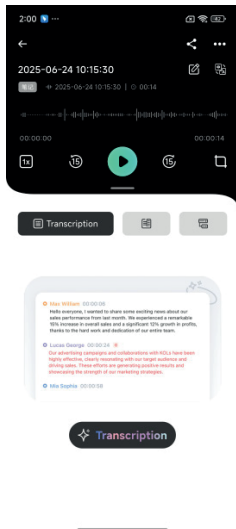

Once the transcription is complete, a **summary** and **mind map** will be generated automatically.

## Manage Files (recordings, transcripts, summaries, mind maps)

After the transcription is finished, you can choose to edit the file name and move it to your customized folders. If you are not satisfied with the transcription or summary, you can re-transcribe or re-summarize the file.

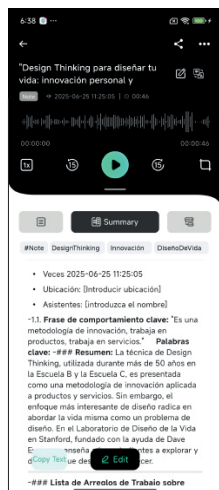

### Notice

Re-transcription will still deduct your transcription minutes. Or you could manually edit the transcripts and summaries by clicking the "Edit" button.

## Export Files(recordings, transcripts,- summaries, mind maps)

If you want to export audio, transcripts, summaries, and mind-maps, there are several formats you can choose:

Export Audio	WAV
Export Transcript	TXT, Markdown, DOCX, PDF
Export Summary	TXT, SRT, DOCX, PDF
Export Mind-map	JPEG, Markdown

# Unbind a Device

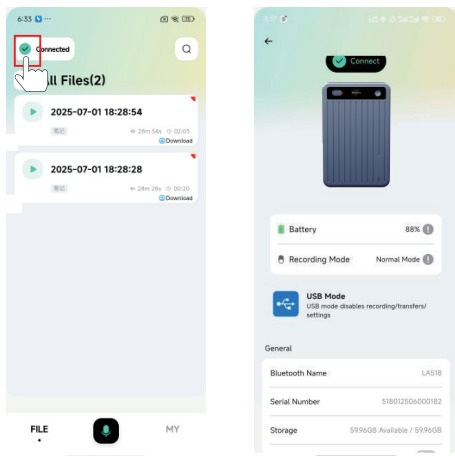

Tap the Connection icon on the main screen to manage device settings:

## 1. Disconnect

End the Bluetooth connection between the device and the app.

## 2. Unbind

Remove the device from the app and clear the binding relationship. In this case, you can connect the device to another cell phone.

# Technical Specifications

USB interface	Type-C USB2.0
Battery Capacity	750 mAh
Memory Capacity	64GB
Rated Input	DC5V 1A
Recording Format	MP3
Working Time	About 90 hours
Weight	54g
Audio Bit Rate	32Kbps
Supported Operating Systems	iOS/Android/ Windows/Linus

# OWLOTECH

OW-REC-MAG-GR

## **AI Recorder Magnus** **Grabadora IA Magnus**

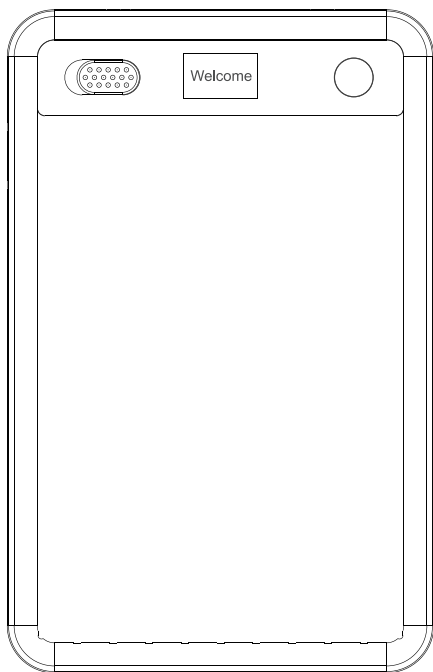



Download the 「AI DVR Link」 App to activate Recorder upon first use.



RoHS



Importado por:  
CIF: B88237342 para OWLOTECH  
C/ Isabel Colbrand 10. Of. 78 28050 Madrid  
OW-REC-MAG-GR  
Lote 4199  
pl.gpsn@pccomponentes.com  
MADE IN P.R.C



8 435674 730861 1

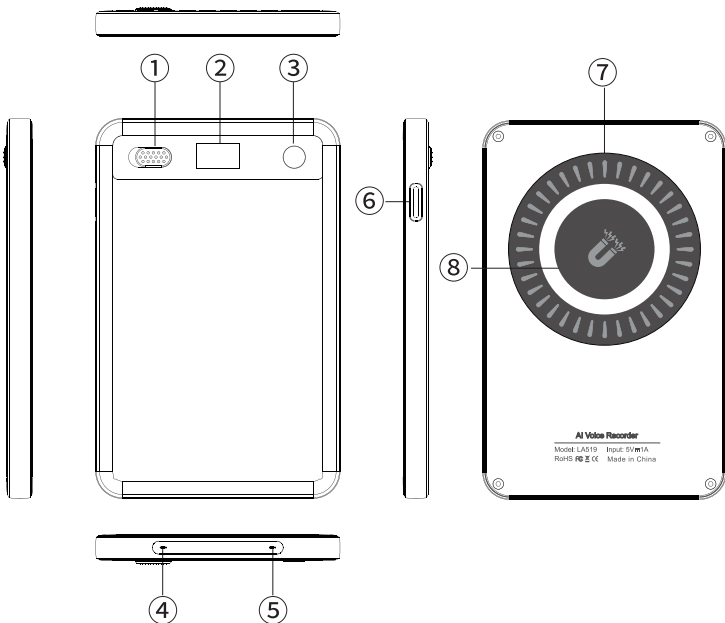

- ① Recording Mode Switch
- ② Screen
- ③ Power/Record Switch
- ④ Microphone
- ⑤ Microphone
- ⑥ Type-C Port
- ⑦ Magnet
- ⑧ Wireless Charging

# Quick Guide



AI DVR Link



- Search for "AI DVR Link" in the App Store or Google Play to download the app.
- Create your App account.

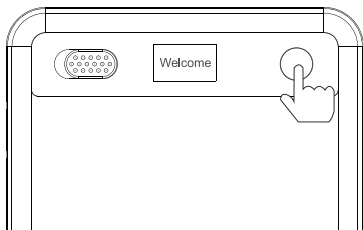

- Long press the Record button for 3 seconds.
- A "Welcome" message will appear on the screen.

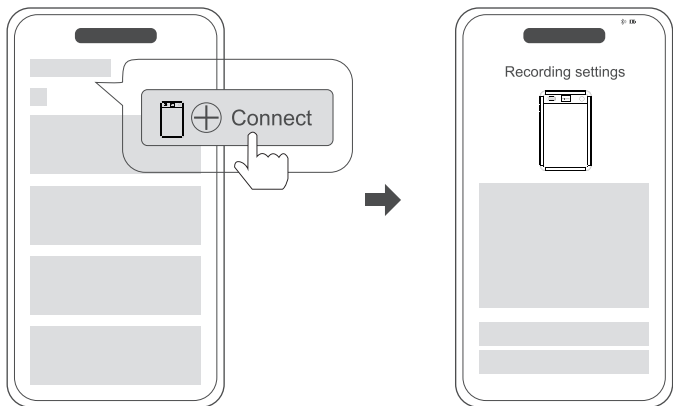

- Open the "AI DVR Link" app and follow the on-screen instructions to bind the device.
- Upon successful binding, the device will display the Bluetooth icon shown above.

# Start Recording

## **NOTE Recording Mode**

- Toggle right to enter NOTE recording mode.
- In this mode, hold Recorder in your hand or place it on a desk to start recording.

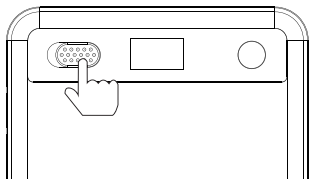

## **CALL Recording Mode**

- Toggle left to enter CALL recording mode.
- In this mode, Recorder can capture the vibration of the phone, providing accurate records.

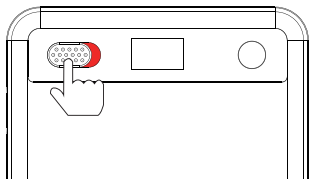

## **Notice**

For phone call recording, you must ensure that the voice recorder is in Call Recording mode and is securely attached to the back of the phone with the supplied MagSafe case.

## Start Recording

Short press the record button and you can feel 1 vibration, indicating that recording has started.

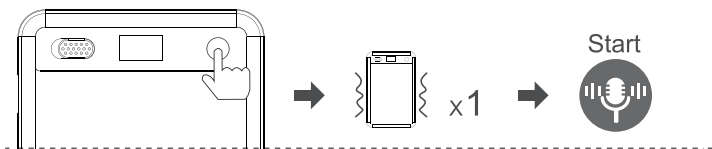

## End Recording

Short press the record button and you can feel 2 vibrations, indicating that the recording has ended.

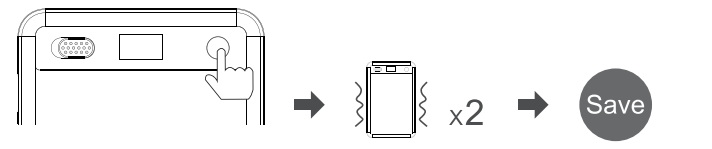

## Start Recording via App

Open the app and tap the Record button to start recording. Ensure AI DVR Link maintains app connection during recording.

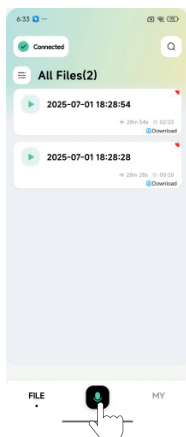

### Notice

#### Auto-Reconnection Feature

When powering off without manual unbinding/disconnection

- The recorder automatically reconnects to AI DVR Link upon restart
- No repeated pairing required for subsequent recordings

## End Recording via App

Tap once during recording to pause, and tap again to **resume**.

Tap the **Save** button to finish and save the recording.

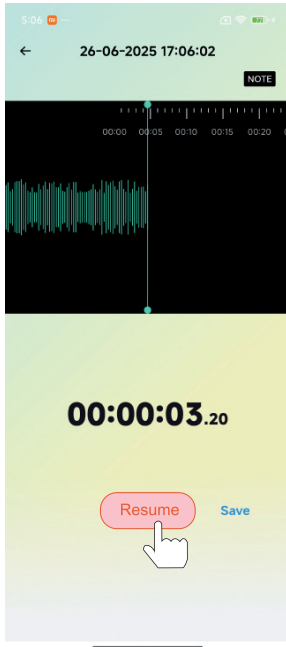

# Recording File Sync

After connecting, existing audio files on the device will appear in the app automatically.

## Before Playback:

1. Synchronize the file with the app
2. Tap the Play button to listen.

1. Please sync the audio file to the app first

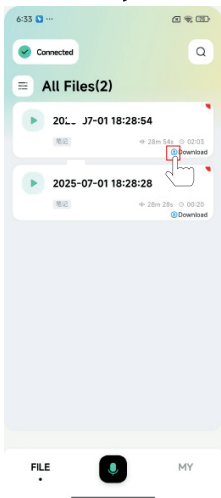

2. Synchronization completed. Click the play button to play the current file.

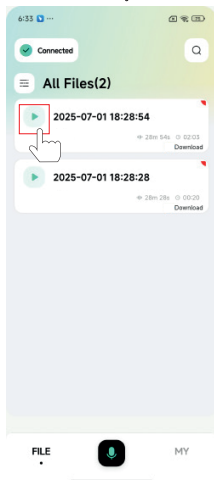

## Recording File Sync via Computer

1. Connect the recorder to your computer using the supplied USB cable.

- The recorder powers on automatically
- Connection icon appears on screen

2. For initial connection:

- Computer prompts for driver installation
- Wait until "My Computer" (Windows) recognizes a new drive

3. When connection is confirmed:

- Transfer/read/manage files

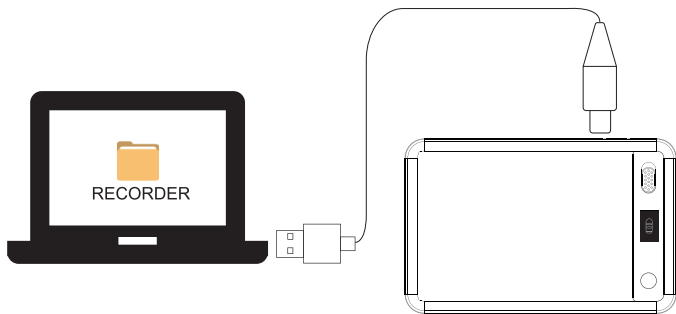

## Warning

Never disconnect during file transfer, as this may cause data loss.

## Support Wireless Charger



(Optional)

# OTG Feature

How to use OTG: Use the included USB cable and OTG adapter to connect the recorder to your cell phone. (The cell phone must have OTG feature)

1. Android phone connected successfully will automatically pop up USB disk prompts, click on it to enter the corresponding folder to manage files.

2. After the iPhone is successfully connected, inside the system folder, select Browse to find the USB disk, then click and find the corresponding folder to manage files.

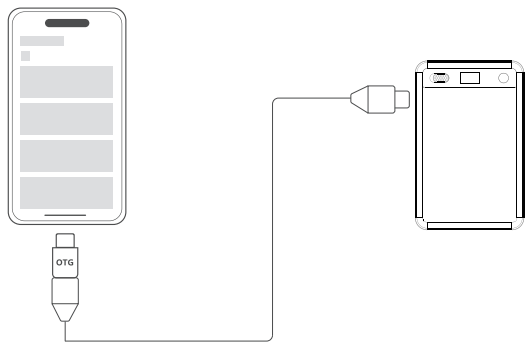

# APP Features

## Transcription Generation

After the audio files are successfully synced to the app, tap on a file to start transcription.

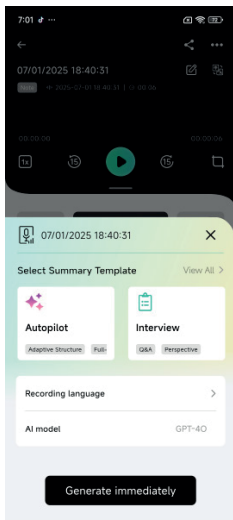
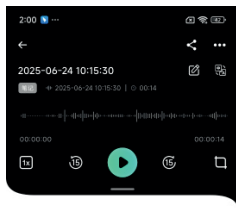

Once the transcription is complete, a **summary** and **mind map** will be generated automatically.

## Manage Files (recordings, transcripts, summaries, mind maps)

After the transcription is finished, you can choose to edit the file name and move it to your customized folders. If you are not satisfied with the transcription or summary, you can re-transcribe or re-summarize the file.

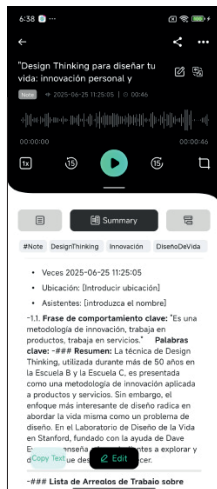

### Notice

Re-transcription will still deduct your transcription minutes. Or you could manually edit the transcripts and summaries by clicking the "Edit" button.

## Export Files(recordings, transcripts,- summaries, mind maps)

If you want to export audio, transcripts, summaries, and mind-maps, there are several formats you can choose:

Export Audio	WAV
Export Transcript	TXT, Markdown, DOCX, PDF
Export Summary	TXT, SRT, DOCX, PDF
Export Mind-map	JPEG, Markdown

# Unbind a Device

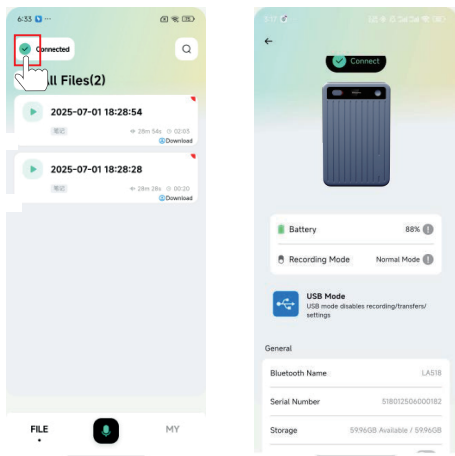

Tap the Connection icon on the main screen to manage device settings:

## 1. Disconnect

End the Bluetooth connection between the device and the app.

## 2. Unbind

Remove the device from the app and clear the binding relationship. In this case, you can connect the device to another cell phone.

# Technical Specifications

USB interface	Type-C USB2.0
Battery Capacity	750 mAh
Memory Capacity	64GB
Rated Input	DC5V 1A
Recording Format	MP3
Working Time	About 90 hours
Weight	54g
Audio Bit Rate	32Kbps
Supported Operating Systems	iOS/Android/ Windows/Linus